

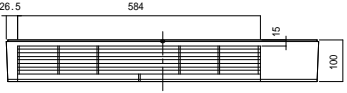

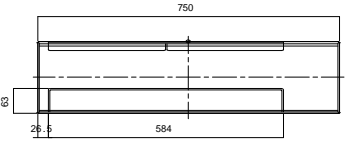

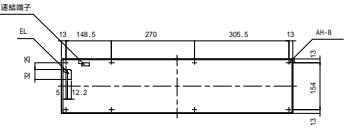

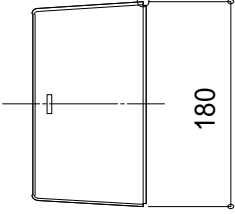
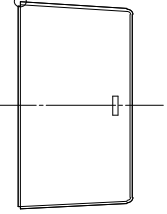
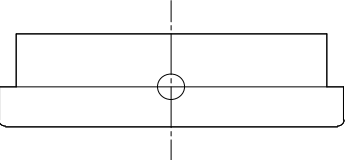
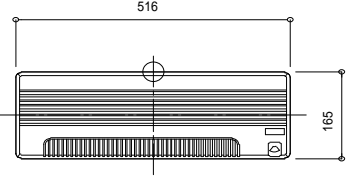
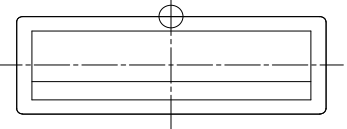
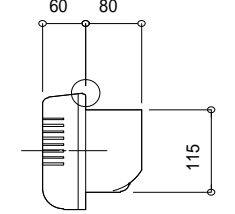
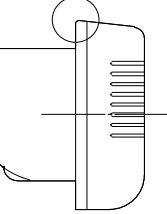
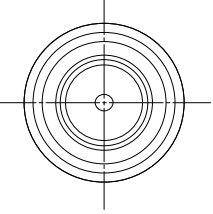
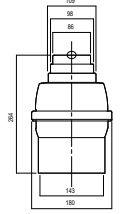
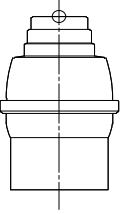
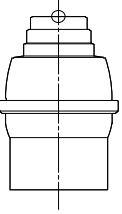
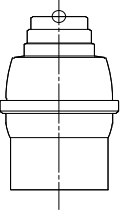
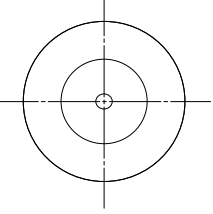
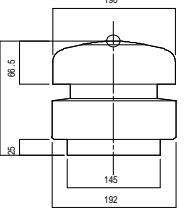
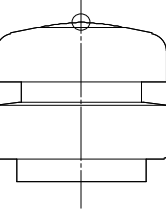
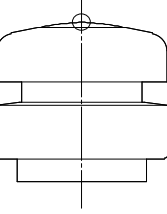
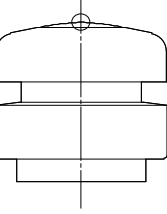
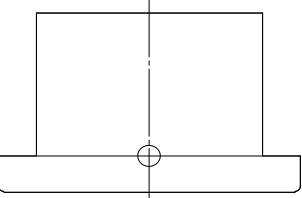
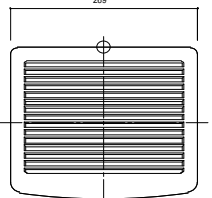
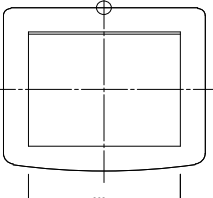
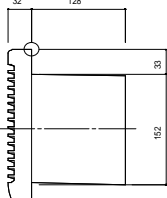
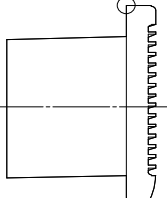
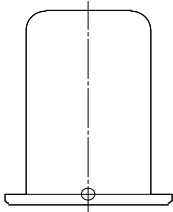
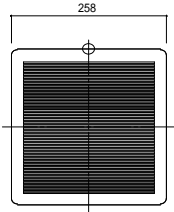
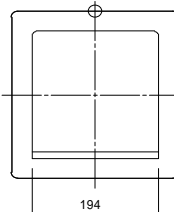
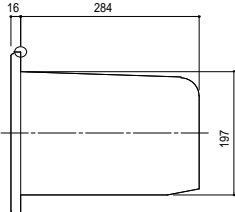
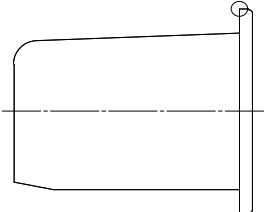
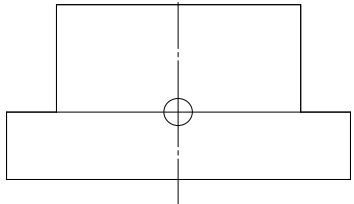
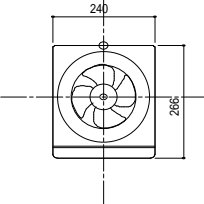
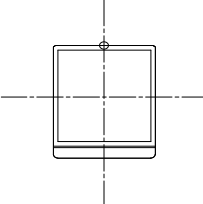

<p>07SB0001.DXF</p> 	<p>07SB0002.DXF</p> 	<p>07SB0003.DXF</p> 	<p>07SB0004.DXF</p> 	<p>07SB0005.DXF</p> 
<p>08RBWC01.DXF</p> 	<p>08RBWC02.DXF</p> 	<p>08RBWC03.DXF</p> 	<p>08RBWC04.DXF</p> 	<p>08RBWC05.DXF</p> 
<p>12CA3001.DXF</p> 	<p>12CA3002.DXF</p> 	<p>12CA3003.DXF</p> 	<p>12CA3004.DXF</p> 	<p>12CA3005.DXF</p> 
<p>12CE3001.DXF</p> 	<p>12CE3002.DXF</p> 	<p>12CE3003.DXF</p> 	<p>12CE3004.DXF</p> 	<p>12CE3005.DXF</p> 
<p>13U00001.DXF</p> 	<p>13U00002.DXF</p> 	<p>13U00003.DXF</p> 	<p>13U00004.DXF</p> 	<p>13U00005.DXF</p> 

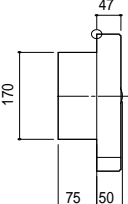
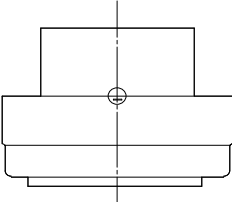
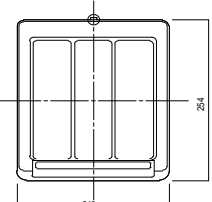
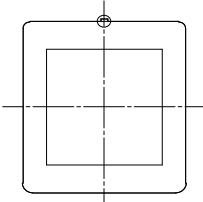
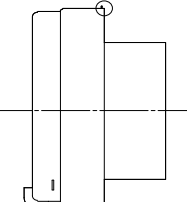
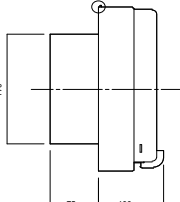
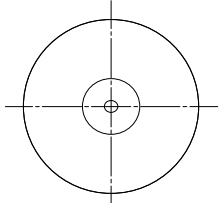
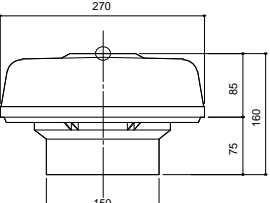
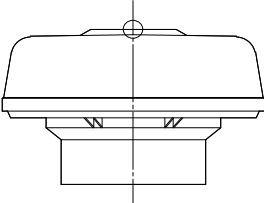
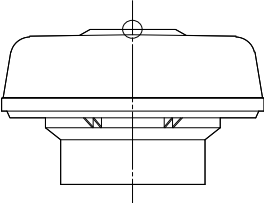
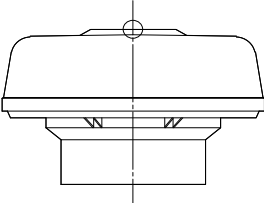
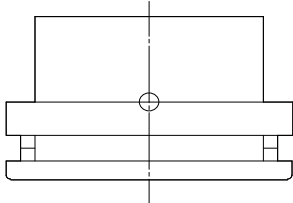
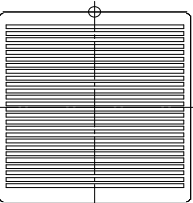
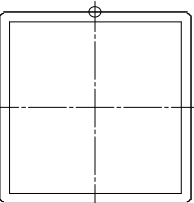
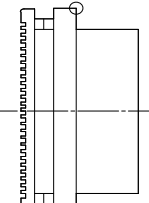
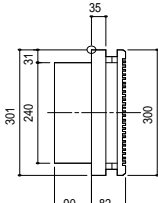
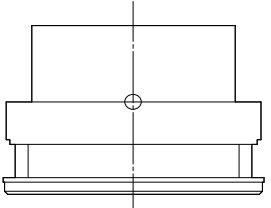
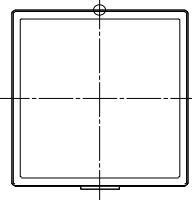
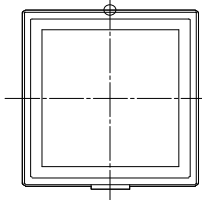
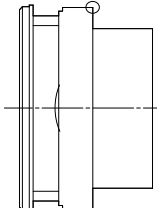
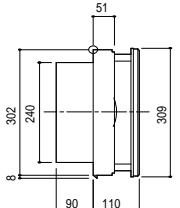
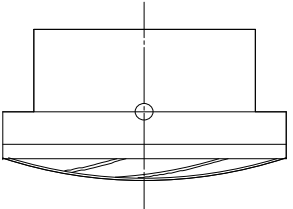
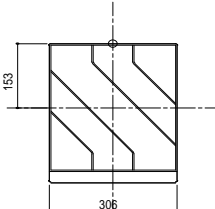
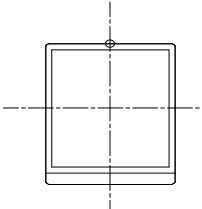
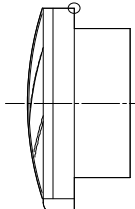
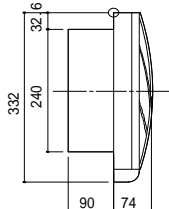
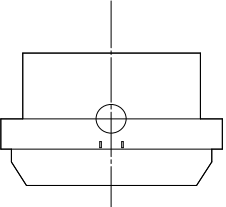
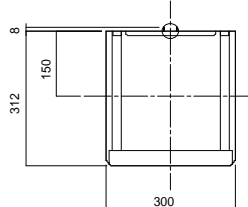
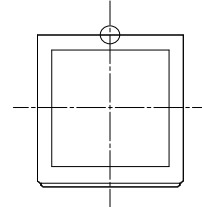
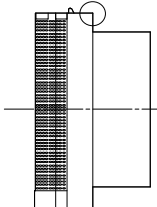
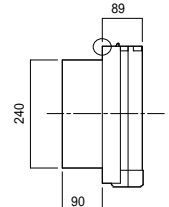
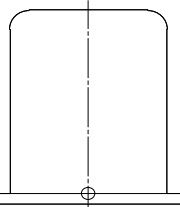
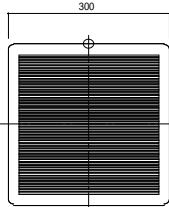
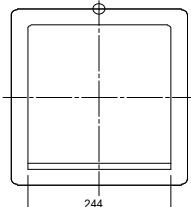
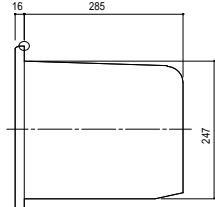
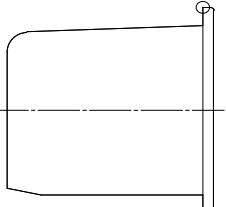
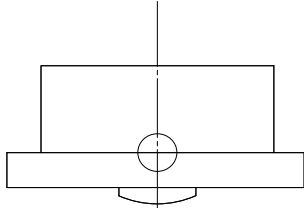
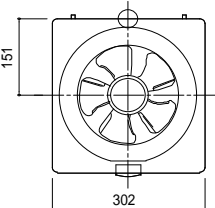
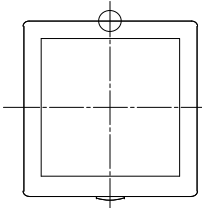
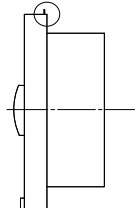
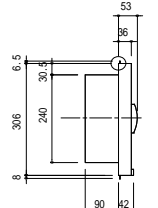
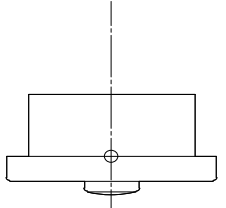
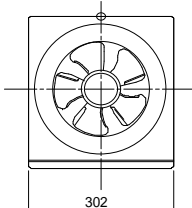
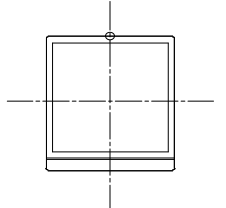
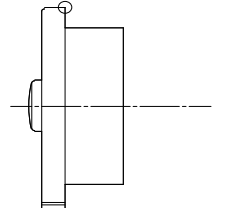
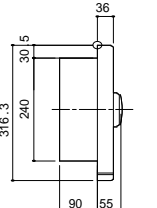
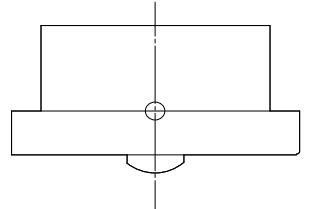
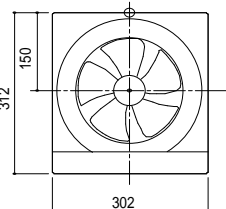
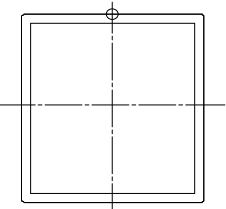
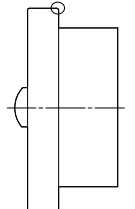
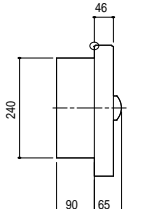
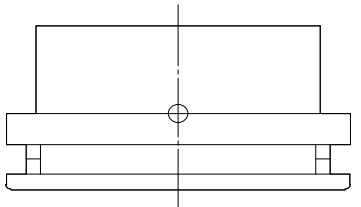
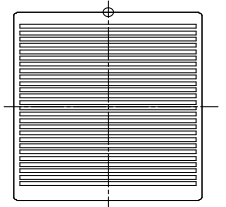
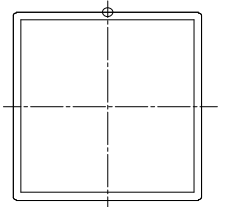
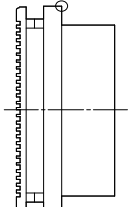
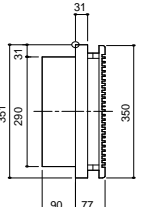
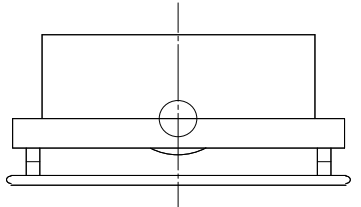
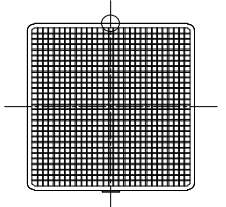
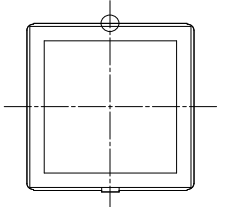
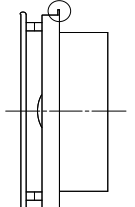
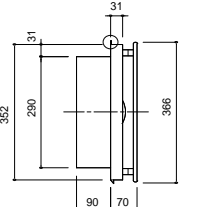
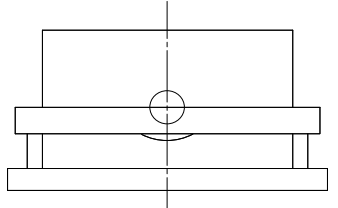
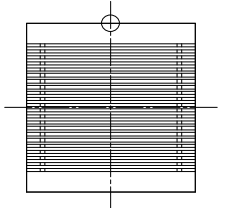
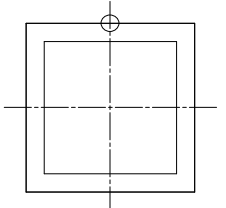
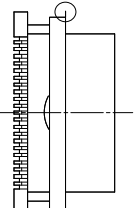
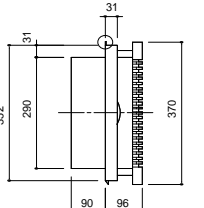
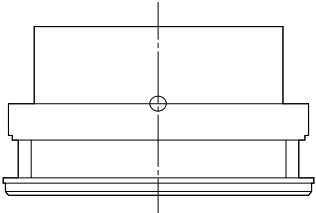
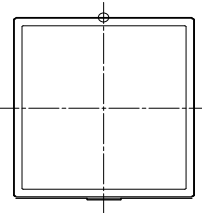
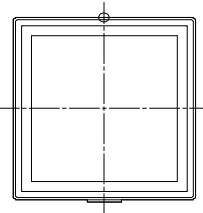

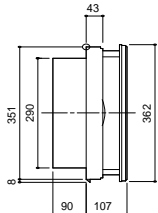
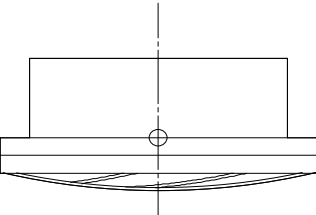
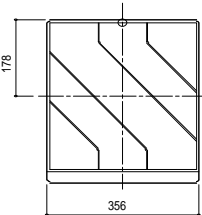
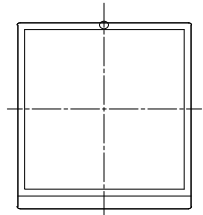
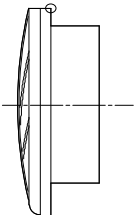
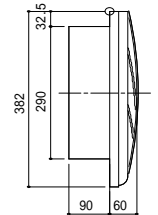
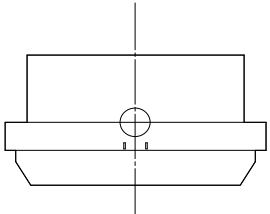
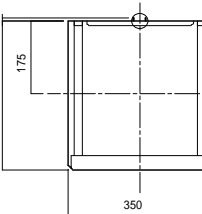
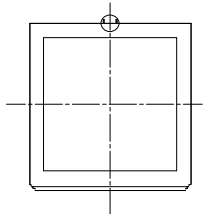
<p>15EK1111.DXF</p> 	<p>15EK1112.DXF</p> 	<p>15EK1113.DXF</p> 	<p>15EK1114.DXF</p> 	<p>15EK1115.DXF</p> 
<p>15PF2BL1.DXF</p> 	<p>15PF2BL2.DXF</p> 	<p>15PF2BL3.DXF</p> 	<p>15PF2BL4.DXF</p> 	<p>15PF2BL5.DXF</p> 
<p>15PG2001.DXF</p> 	<p>15PG2002.DXF</p> 	<p>15PG2003.DXF</p> 	<p>15PG2004.DXF</p> 	<p>15PG2005.DXF</p> 
<p>18CE2001.DXF</p> 	<p>18CE2002.DXF</p> 	<p>18CE2003.DXF</p> 	<p>18CE2004.DXF</p> 	<p>18CE2005.DXF</p> 
<p>20EE4431.DXF</p> 	<p>20EE4432.DXF</p> 	<p>20EE4433.DXF</p> 	<p>20EE4434.DXF</p> 	<p>20EE4435.DXF</p> 

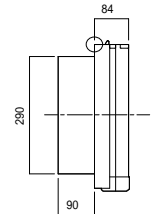
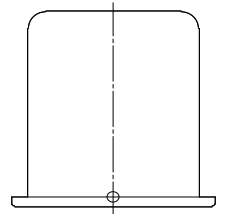
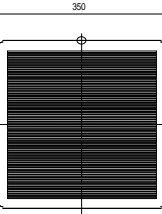
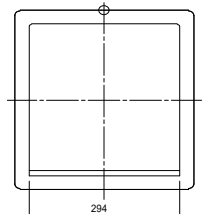
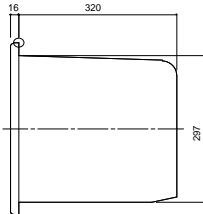
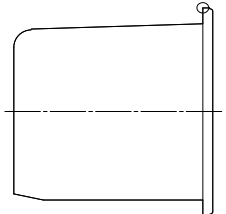
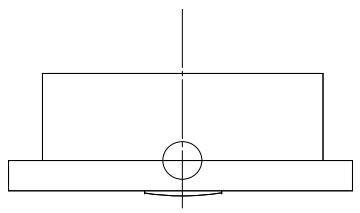
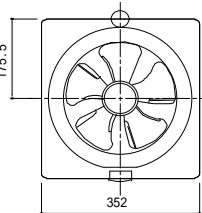
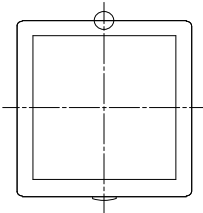
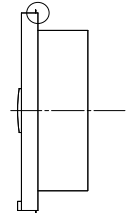
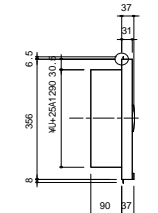
<p>20EEP401.DXF</p> 	<p>20EEP402.DXF</p> 	<p>20EEP403.DXF</p> 	<p>20EEP404.DXF</p> 	<p>20EEP405.DXF</p> 
<p>20EH4001.DXF</p> 	<p>20EH4002.DXF</p> 	<p>20EH4003.DXF</p> 	<p>20EH4004.DXF</p> 	<p>20EH4005.DXF</p> 
<p>20EJM501.DXF</p> 	<p>20EJM502.DXF</p> 	<p>20EJM503.DXF</p> 	<p>20EJM504.DXF</p> 	<p>20EJM505.DXF</p> 
<p>20EK1111.DXF</p> 	<p>20EK1112.DXF</p> 	<p>20EK1113.DXF</p> 	<p>20EK1114.DXF</p> 	<p>20EK1115.DXF</p> 
<p>20P50001.DXF</p> 	<p>20P50002.DXF</p> 	<p>20P50003.DXF</p> 	<p>20P50004.DXF</p> 	<p>20P50005.DXF</p> 

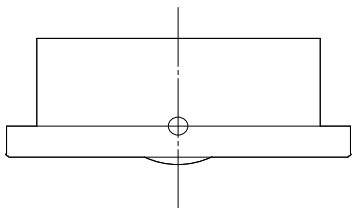
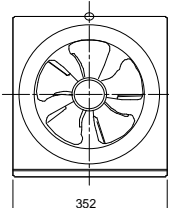
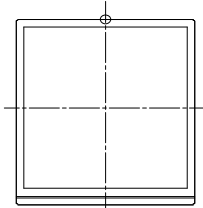
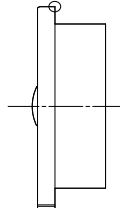
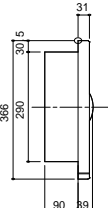
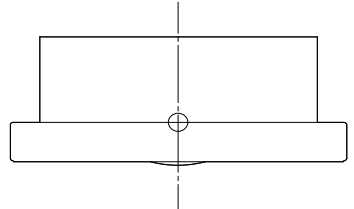
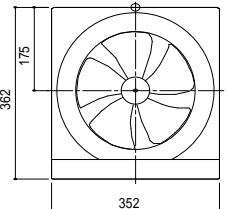
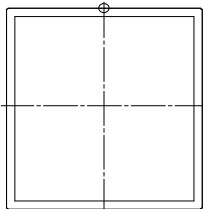
<p>20PF4001.DXF</p> 	<p>20PF4002.DXF</p> 	<p>20PF4003.DXF</p> 	<p>20PF4004.DXF</p> 	<p>20PF4005.DXF</p> 
<p>20SM2001.DXF</p> 	<p>20SM2002.DXF</p> 	<p>20SM2003.DXF</p> 	<p>20SM2004.DXF</p> 	<p>20SM2005.DXF</p> 
<p>25EE4431.DXF</p> 	<p>25EE4432.DXF</p> 	<p>25EE4433.DXF</p> 	<p>25EE4434.DXF</p> 	<p>25EE4435.DXF</p> 
<p>25EE5051.DXF</p> 	<p>25EE5052.DXF</p> 	<p>25EE5053.DXF</p> 	<p>25EE5054.DXF</p> 	<p>25EE5055.DXF</p> 
<p>25EE5131.DXF</p> 	<p>25EE5132.DXF</p> 	<p>25EE5133.DXF</p> 	<p>25EE5134.DXF</p> 	<p>25EE5135.DXF</p> 

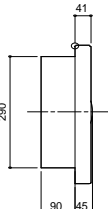
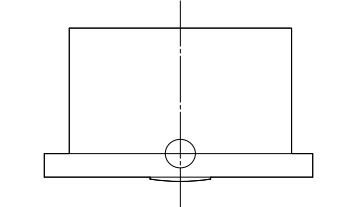
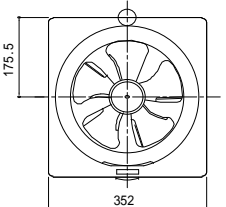
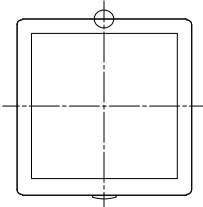
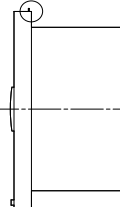
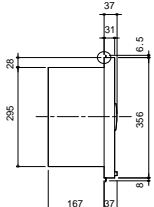
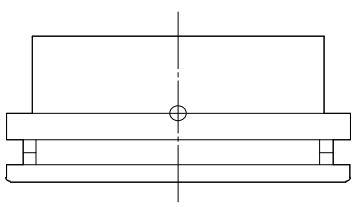
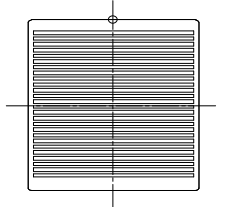
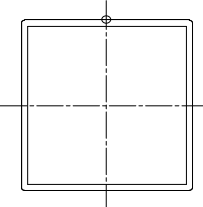
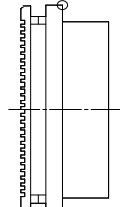
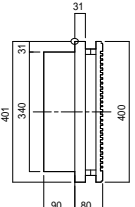
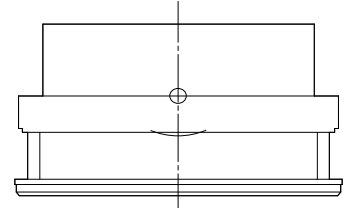
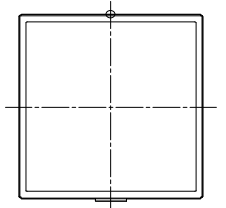
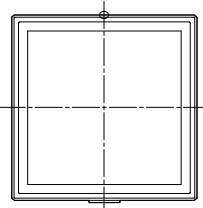
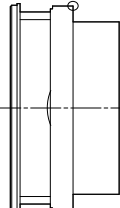
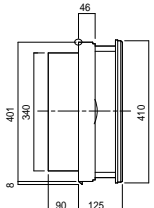
<p>25EEP401.DXF</p> 	<p>25EEP402.DXF</p> 	<p>25EEP403.DXF</p> 	<p>25EEP404.DXF</p> 	<p>25EEP405.DXF</p> 
<p>25EH4001.DXF</p> 	<p>25EH4002.DXF</p> 	<p>25EH4003.DXF</p> 	<p>25EH4004.DXF</p> 	<p>25EH4005.DXF</p> 
<p>25EJM501.DXF</p> 	<p>25EJM502.DXF</p> 	<p>25EJM503.DXF</p> 	<p>25EJM504.DXF</p> 	<p>25EJM505.DXF</p> 
<p>25EK1111.DXF</p> 	<p>25EK1112.DXF</p> 	<p>25EK1113.DXF</p> 	<p>25EK1114.DXF</p> 	<p>25EK1115.DXF</p> 
<p>25P50001.DXF</p> 	<p>25P50002.DXF</p> 	<p>25P50003.DXF</p> 	<p>25P50004.DXF</p> 	<p>25P50005.DXF</p> 

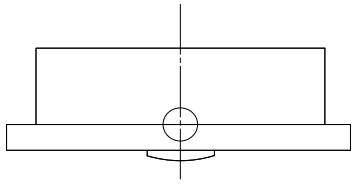
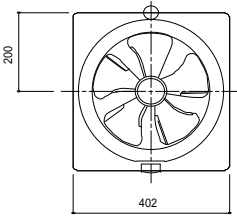
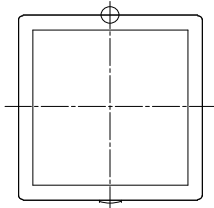
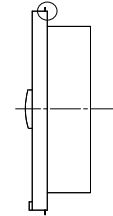
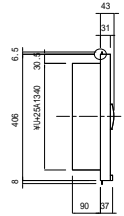
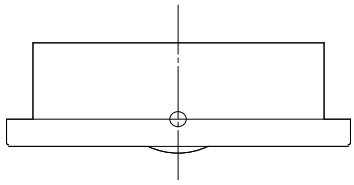
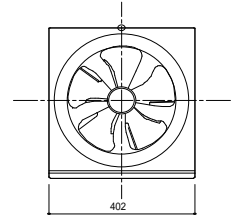
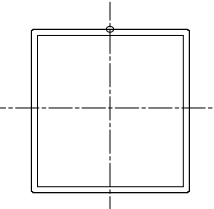
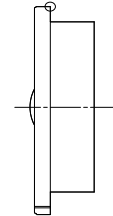
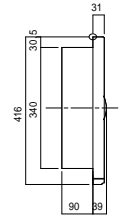
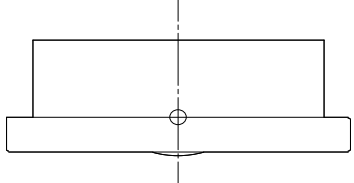
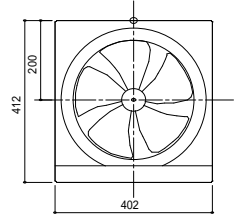
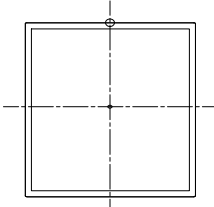
<p>25PF4001.DXF</p> 	<p>25PF4002.DXF</p> 	<p>25PF4003.DXF</p> 	<p>25PF4004.DXF</p> 	<p>25PF4005.DXF</p> 
<p>25SM2001.DXF</p> 	<p>25SM2002.DXF</p> 	<p>25SM2003.DXF</p> 	<p>25SM2004.DXF</p> 	<p>25SM2005.DXF</p> 
<p>25ZF5001.DXF</p> 	<p>25ZF5002.DXF</p> 	<p>25ZF5003.DXF</p> 	<p>25ZF5004.DXF</p> 	<p>25ZF5005.DXF</p> 
<p>30EE4431.DXF</p> 	<p>30EE4432.DXF</p> 	<p>30EE4433.DXF</p> 	<p>30EE4434.DXF</p> 	<p>30EE4435.DXF</p> 
<p>30EEP401.DXF</p> 	<p>30EEP402.DXF</p> 	<p>30EEP403.DXF</p> 	<p>30EEP404.DXF</p> 	<p>30EEP405.DXF</p> 

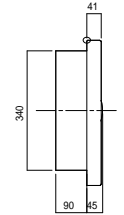
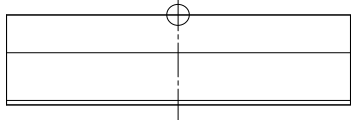
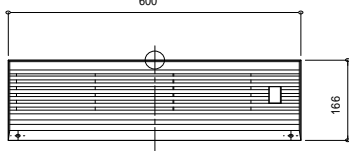
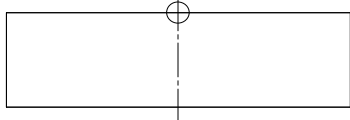
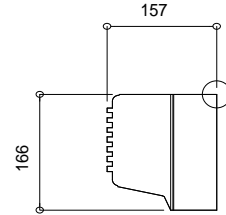
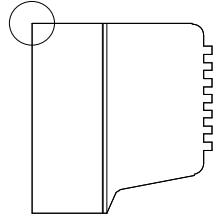
<p>30P50001.DXF</p> 	<p>30P50002.DXF</p> 	<p>30P50003.DXF</p> 	<p>30P50004.DXF</p> 	<p>30P50005.DXF</p> 
<p>30PF4001.DXF</p> 	<p>30PF4002.DXF</p> 	<p>30PF4003.DXF</p> 	<p>30PF4004.DXF</p> 	<p>30PF4005.DXF</p> 
<p>30SM2001.DXF</p> 	<p>30SM2002.DXF</p> 	<p>30SM2003.DXF</p> 	<p>30SM2004.DXF</p> 	<p>30SM2005.DXF</p> 
<p>60SW0001.DXF</p> 	<p>60SW0002.DXF</p> 	<p>60SW0003.DXF</p> 	<p>60SW0004.DXF</p> 	<p>60SW0005.DXF</p> 
<p> </p>	<p> </p>	<p> </p>	<p> </p>	<p> </p>